



Larks Hill Year 2: Home Learning Schedule

W/C 29 th June	Monday	Tuesday	Wednesday	Thursday	Friday
Maths <i>Suggested timing: 45 mins per lesson</i>	Lesson 1: To relate halves and quarters to division	Lesson 2: To identify the parts of a fraction	Lesson 3: To identify half of a shape	Lesson 4: To identify halves, thirds and quarters of shapes	Lesson 5: To identify fractions of shapes with different numerators
This week we will be focusing on: Fractions We have produced a 'pre-teach' video to introduce this week's learning in maths. We recommend watching the video before commencing Lesson 1. Please click here to view this.	Click here for the Oak Academy online lesson. <i>Learn how to use halves and quarters to support division.</i>	Click here for the Oak Academy online lesson. <i>Understand and use the different parts of a fraction.</i>	Click here for the Oak Academy online lesson. <i>Learn how to halve a variety of different shapes.</i>	Click here for the Oak Academy online lesson. <i>Building on the previous session, learn to find thirds and quarters of shapes.</i>	Click here for the Oak Academy online lesson. <i>Learn how to identify fractions of shapes when the numerators differ.</i>

Remember to log in to TTRockstars each week to practise your times tables!

Remember to share your learning on Class Dojo!

Take a photo of your work and upload it to the Portfolio section for your teacher to see.

W/C 29 th June	Monday	Tuesday	Wednesday	Thursday	Friday
English <i>Suggested timing: 45 mins per lesson</i>	Lesson 1: To make inferences from a piece of text.	Lesson 2: To make inferences from a piece of text.	Lesson 3: To identify the features of a character description.	Lesson 4: To identify and use expanded noun phrases.	Lesson 5: To write a character description.
This week our text type is a: Character Description This week we will have two lessons based on reading and three based on character descriptions. At the end of the week, you will write your own character description of Mr and Mrs Twit. Make sure you watch the pre-teach video at the start of the week! Click here .	In today's lesson you will learn how to make an inference from a piece of text. <i>Click here to watch the video explaining what inference is.</i>	Develop your understanding of making inferences by looking at a different extract from The Twits. <i>Recap on the inference video from the previous session by clicking here.</i>	Learn to identify & explain the key features of a character description. <i>Click here to watch video which explains what a character description is.</i>	Learn how to identify expanded noun phrases and apply your learning by creating some of your own. <i>Click here for a tutorial on expanded noun phrases. You do not need to complete the full lesson.</i>	Apply your learning from the week by writing a character description of Mr or Mrs Twit. <i>Use this short dramatisation as inspiration for your writing. Click here.</i>

This week's spellings are: wild – climb – most – only – both- old – cold – gold – hold – told

Having any problems with the tasks?

Feel free to pop any questions or issues onto our class Padlet [here](#)!

Don't forget to join us every afternoon, Monday to Friday, at 2pm. Click [here](#) to take part in a live discussion on Microsoft Teams about the day's learning alongside your classmates and teacher.



English – Lesson 1

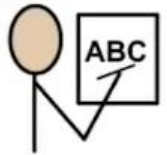





This week's spellings

1. wild
2. climb
3. most
4. only
5. both
6. old
7. cold
8. gold
9. hold
10. told

Use these key skills to support you when answering inference style questions.

Key Skill: Inference

- 1) Read the question 
- 2) Read the text 
- 3) Look for clues 
- 4) Make a good guess at what the answer might be 





English – Lesson 1 - Challenge

Mrs Twit Gets a Stretching

Mr Twit led Mrs Twit outdoors where he had everything ready for the great stretching. He had one hundred balloons and lots of string. He had a glass cylinder for filling balloons. He had fixed an iron ring to the ground. "Stand here," he said, pointing to the iron ring. When that was done, he began filling the balloons with gas. Each balloon was on a long string and when it was filled with gas it pulled on its string, trying to go up and up. Mr Twit tied the ends of the strings to the top half of Mrs Twit's body. Some he tied round her neck, some he tied under her arms, some to her wrists and some even to her hair. Soon there were fifty coloured balloons floating in the air above Mrs Twit's head. "Can you feel them stretching you?" asked Mr Twit.

"I can! I can!" cried Mrs Twit. "They're stretching me like mad".

He put on another ten balloons. The upward pull became very strong. Mrs Twit was quite helpless now. With her feet tied to the ground and her arms pulled upwards by the balloons, she was unable to move. She was a prisoner, and Mr Twit had intended to go away and leave her when Mrs Twit opened her big mouth and said something silly.

"Are you sure my feet are tied properly to the ground?" she gasped. "If those strings around my ankles break, it'll be goodbye for me!"

And that's what gave Mr Twit his second nasty idea.

1) Why do you think Mr Twit needed to attach so many balloons to Mrs Twit?

2) Which of Mrs Twit's body parts does Mr Twit tie the balloons to?

3) Why does Roald Dahl write that Mrs Twit was 'like a prisoner'?

4) Why do you think Mr Twit and Mrs Twit are so nasty to each other?

5) Why do you think the author used the word 'gasped' instead of 'said' when Mrs Twit asks if her feet are tied to the ground properly?



English – Lesson 2

Click [here](#) to watch the video explaining what inference is.

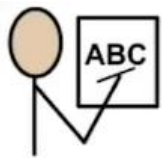



This week's spellings

1. wild
2. climb
3. most
4. only
5. both
6. old
7. cold
8. gold
9. hold
10. told

Use these key skills to support you when answering inference style questions.

Key Skill: Inference

- 1) Read the question ?
- 2) Read the text 
- 3) Look for clues 
- 4) Make a good guess at what the answer might be 





Mrs Twit Goes Ballooning Up

“There’s enough pull here to take me to the moon!” Mrs Twit cried out.

“To take you to *the moon!*” exclaimed Mr Twit. “What a ghastly thought! We wouldn’t want anything like that to happen, oh dear me no!”

“We most certainly wouldn’t!” cried Mrs Twit. “Put some more string around my ankles quickly! I want to feel absolutely safe!”

“Very well, my angel,” said Mr Twit, and with a ghoulish grin on his lips he knelt down at her feet. He took a knife from his pocket and with one quick slash he cut through the string holding Mrs Twit’s ankles to the iron ring. She went up like a rocket.

“Help!” she screamed. “Save me!”

But there was no saving her now. In a few seconds she was high up in the blue sky and climbing fast.

Mr Twit stood below looking up. “*What* a pretty sight!” he said to himself. “How lovely all those balloons look in the sky! And what a marvellous bit of luck for me! At last the old hag is lost and gone forever.”

Mrs Twit may have been ugly and she may have been beastly, but she was not stupid. High up there in the sky, she had a bright idea. “If I can get rid of some of these balloons, I will stop going up and start to come down,” she said to herself. She began biting through the strings that held the balloons to her wrists and arms and neck and hair. Each time she bit through a string and let the balloon float away, the upward pull got less and her rate of climb slowed down. When she had bitten through twenty strings, she stopped going up altogether. She stayed still in the air. She bit through one more string. Very, very slowly, she began to float downwards.

Challenge

1. How do you think Mrs Twit felt when she went into the sky?
2. Why did Mrs Twit have to slowly bite through the balloon strings?
3. What do you think Mr Twit is like as a person?
4. How do you think Mr Twit feels when he sees his plan is working?



English – Lesson 2 – Answers

These are to be used as example answers as with inference-style questions, there can be slightly different viewpoints.

- 1) I think that Mrs Twit would be feeling scared, shocked and angry when she realised that she was floating up in the air because she has no control over her body anymore.
- 2) Mrs Twit had to act very slowly because if she suddenly uncut all of the strings at the same time then this would cause her to quickly fall to the ground and she could cause herself an injury.
- 3) I believe that Mr Twit is a very competitive person because he keeps on playing tricks on Mrs Twit. I also think that he is very selfish, mean and vindictive person.
- 4) I think Mr Twit is feeling thrilled when he realises that his plan is working because he thinks that he has finally got rid of his wife.



English – Lesson 3

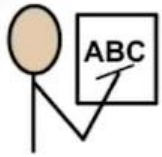

This week's spellings

1. wild
2. climb
3. most
4. only
5. both
6. old
7. cold
8. gold
9. hold
10. told



Features of a character description

1. Heading

2. Expanded Noun Phrases to describe the character's appearance

3. Adjectives to describe the character's personality

4. Conjunctions (when & because)



English – Lesson 3 - Challenge

Read the text below and identify the key features of a character description. Use the following key if you have these colours – or alternatively, make up your own key:

1. Heading:

2. Expanded Noun Phrase:

3. Adjectives

4. Conjunctions



Adjectives

An **adjective** is a word that describes a **noun**.

A **noun** is a person, place or a thing.



Expanded Noun Phrase

An expanded noun phrase has a **determiner** (a, an, the) **adjective** (describing word) and then a **noun** (a person place of thing.)



Mr Twit

Mr Twit is a nasty, horrible man of 60 years of age, who is married to Mrs Twit. Mr Twit has a large, hideous, and filthy beard which reflects his cruel inner nature. He is one of these very hairy-faced men. The whole of his face, except for his forehead, his eyes and his nose are covered with thick hair. The bristly hairs even sprout in revolting tufts out of his nostrils and ear-holes. Mr Twit wears the same pungent clothes every day because he hates having to do any kind of chore. Mr Twit dribbles gravy down his chin onto his top then when this happens, licks it off, relishing the stale flavours. Mr Twit spends his days playing cruel tricks on Mrs Twit because they have a rivalry between them.



English – Lesson 3 – Answers

Mr Twit

Mr Twit is a nasty, horrible man of 60 years of age who is married to Mrs Twit. Mr Twit has a large, hideous, and filthy beard which reflects his cruel inner nature. He is one of these very hairy-faced men. The whole of his face except for his forehead, his eyes and his nose are covered with thick hair. The bristly hairs even sprout in revolting tufts out of his nostrils and ear-holes. Mr Twit wears the same pungent clothes every day because he hates having to do any kind of chore. Mr Twit dribbles gravy down his chin onto his top then when this happens, licks it off, relishing the stale flavours. Mr Twit spends his days playing cruel tricks on Mrs Twit because they have a rivalry between them.

Heading

Expanded noun phrases

Adjectives

Conjunctions (when & because)

Review

How many features did you manage to find? _____

Can you spot where you made mistakes? _____

What have you learned today? _____



English – Lesson 4

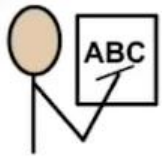

This week's spellings

1. wild
2. climb
3. most
4. only
5. both
6. old
7. cold
8. gold
9. hold
10. told

Key reminder of previous learning and

VIPS!



Adjectives

An **adjective** is a word that describes a **noun**.

A **noun** is a person, place or a thing.

*The tree is **tall**.*

*The girl was feeling **excited**.*



Expanded Noun Phrases



The tall, leafy tree.

↑ ↑ ↓ ↑
adjective comma adjective noun

An expanded noun phrase has a **determiner** (a, an, the) **adjective** (describing word) and then a **noun** (a person place of thing.)



English – Lesson 4

Challenge 1

Can you identify the expanded noun phrases in the following passage?



Let's read the passage.

Let's find the expanded noun phrases.

Expanded Noun Phrase

lovely, green grass
(adjective, adjective noun)

It was a bright, sunny day. The trees were swaying in the cool, fresh breeze and the birds were tweeting. The little boy could see a tiny boat moving across the shiny, blue water.

Challenge 2

Using the clues and adjectives below write down at least three expanded noun phrases you could use to describe Mr or Mrs Twit.

1. The, an, a
2. adjective
3. noun

Or

1. The, an, a
2. adjective
3. comma
4. adjective
5. noun



caring	rude	happy	
beautiful	friendly	polite	
angry	ugly	sly	evil
clever	handsome	kind	
honest	nasty	gentle	
pretty	wicked	cross	
grumpy	horrible	brave	
shy	mean	noble	
wise	calm	bold	
helpful	scary	smart	
furious	cunning	unkind	
unkind	cruel	charming	



English lesson 4 – Answers

The highlighted sections are the expanded noun phrases.

It was **a bright sunny day**. The trees were swaying in **the cool, fresh breeze** and the birds were tweeting. The little boy could see **a tiny boat** moving across **the shiny, blue water**.



English – Lesson 5

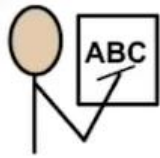

This week's spellings

1. wild
2. climb
3. most
4. only
5. both
6. old
7. cold
8. gold
9. hold
10. told



Key reminder of previous learning and

VIPS!

Features of a character description

1. Heading

2. Expanded Noun Phrases to describe the character's appearance

3. Adjectives to describe the character's personality

4. Conjunctions (when & because)



English – Lesson 5

Remember everything you have learned this week and apply it in this piece of writing. Below you are going to create your own character description of the Twits.



The Twits



caring rude happy
beautiful friendly polite
angry ugly sly evil
clever handsome kind
honest nasty gentle
pretty wicked cross
grumpy horrible brave
shy mean noble
wise calm bold
helpful scary smart
furious cunning unkind
unkind cruel charming

Can you write a paragraph about these characters?



Maths – Lesson 1

The worksheet contains four dot-and-cross puzzles arranged in a 2x2 grid. Each puzzle is a square grid of yellow squares, each containing either a black dot or a black cross. Lines connect the corners of each grid to the corners of four empty rectangular boxes on the right, intended for the student to write their answers.

- Top-left puzzle:** A 3x3 grid with 8 dots and 2 crosses. The crosses are at the bottom-left and bottom-middle positions.
- Top-right puzzle:** A 3x4 grid with 12 dots and 0 crosses.
- Bottom-left puzzle:** A 4x4 grid with 16 dots and 0 crosses.
- Bottom-right puzzle:** A 4x5 grid with 20 dots and 0 crosses.



Maths – Lesson 1 continued

Now, create your own!

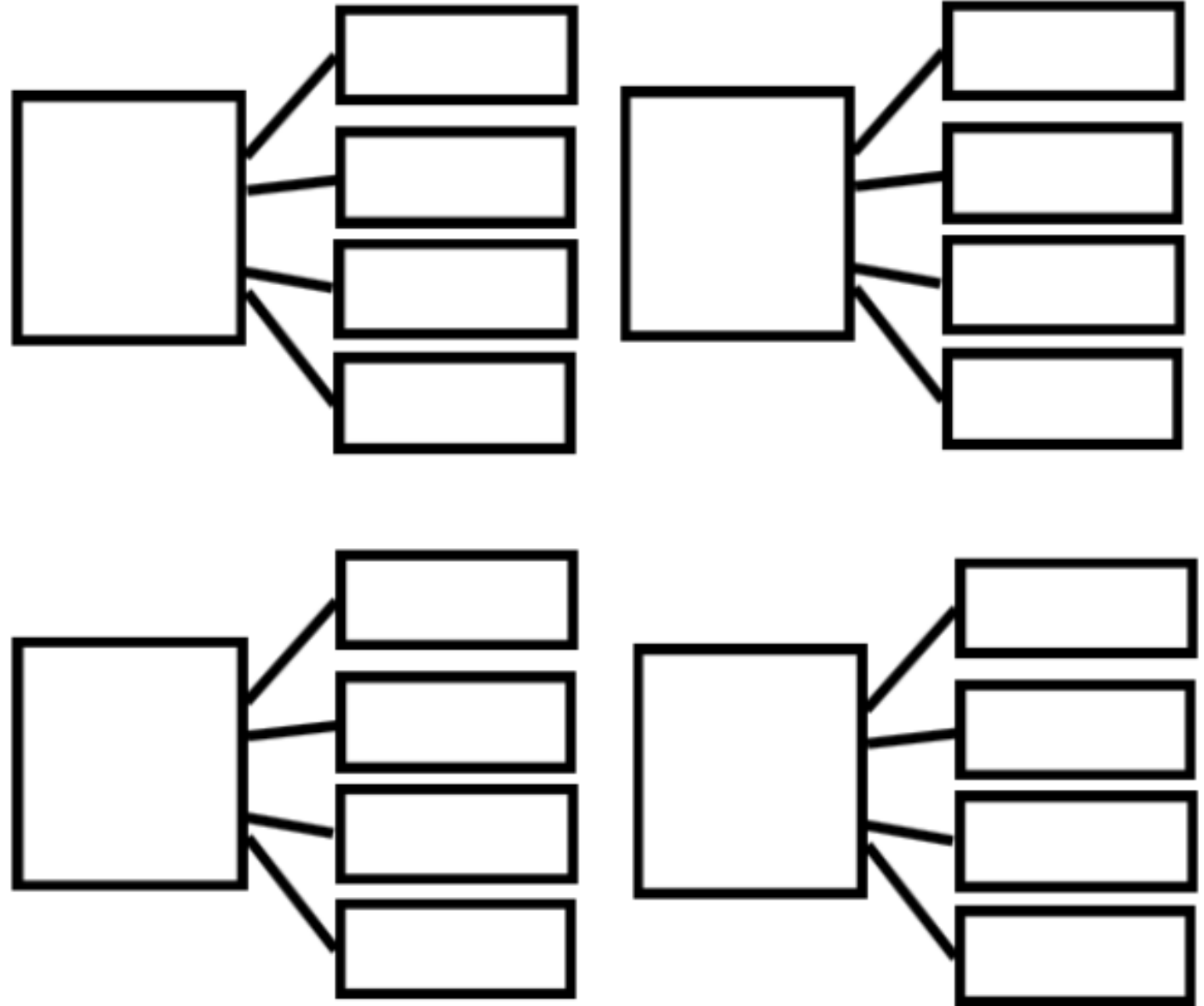



Maths – Lesson 1 Answers

$8 \div 4 = 2$

$12 \div 4 = 3$

$16 \div 4 = 4$

$20 \div 4 = 5$



Maths – Lesson 2

Independent Task 1



1.

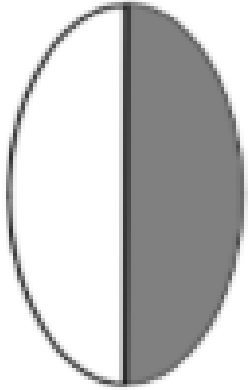

2.

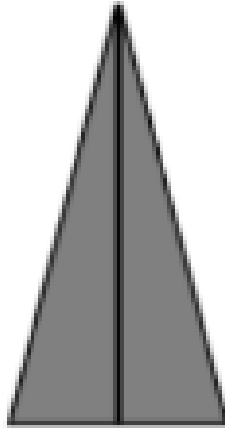

3.

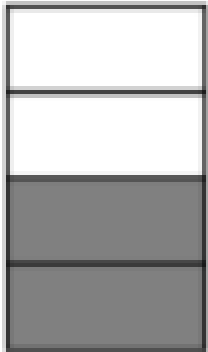

4.

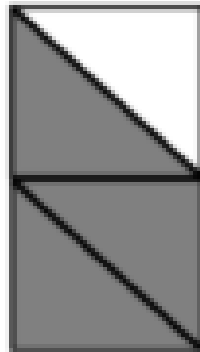

Independent Task – Can you draw other representations that show the same fraction?

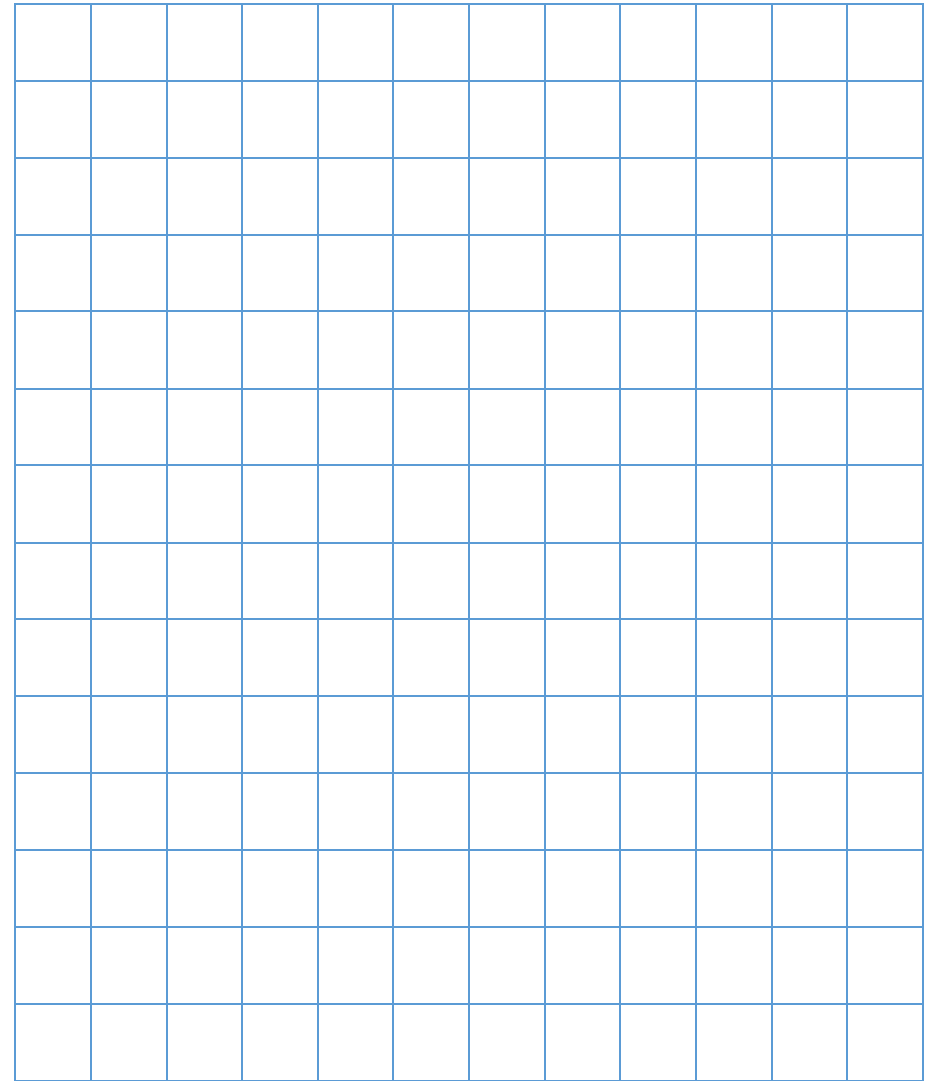



Maths – Lesson 2 **Answers**

1. $\frac{1}{2}$

2. 1

3. $\frac{2}{4} = \frac{1}{2}$

4. $\frac{3}{4}$



Maths – Lesson 3

You will need both a pencil and ruler for this lesson.

Use a separate piece of A4 paper to find as many different ways of halving the shapes below! You may draw the lines using a pencil. **Extra challenge: Name each shape.**

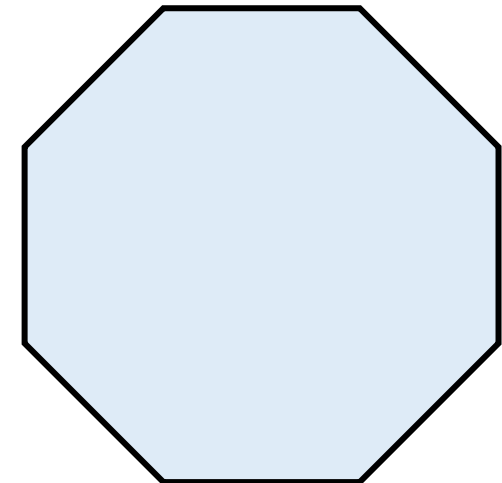
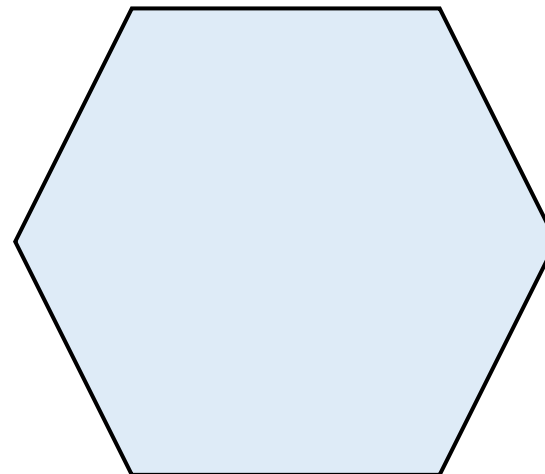
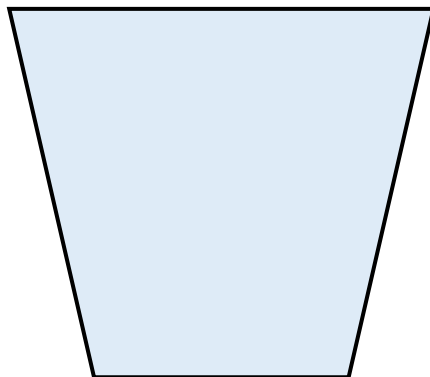
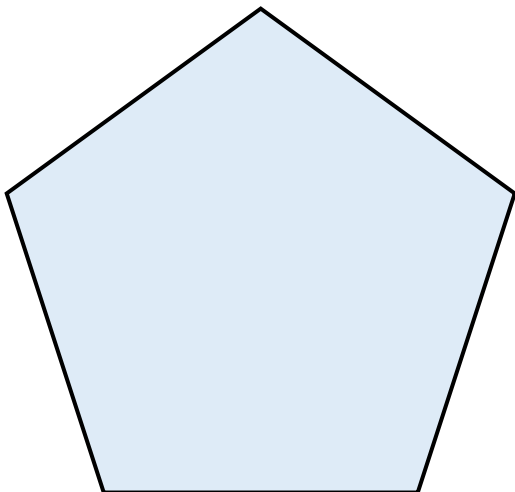
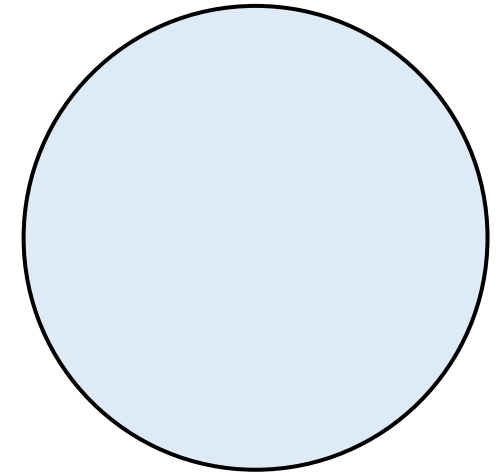
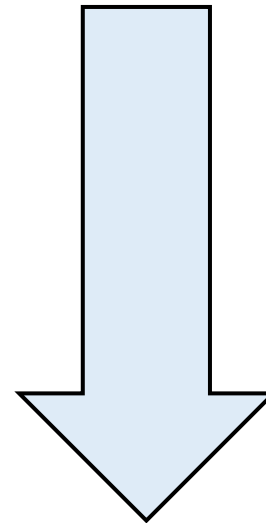
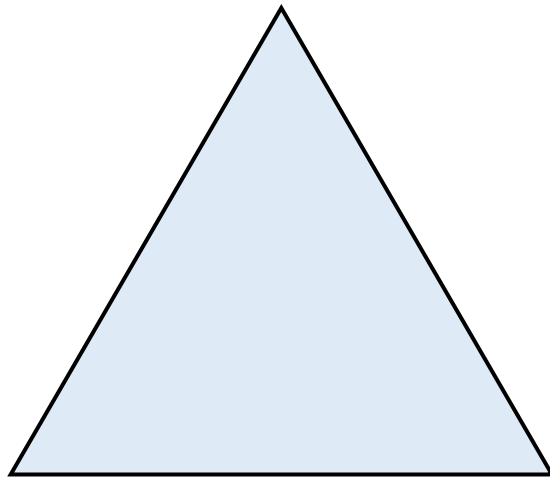
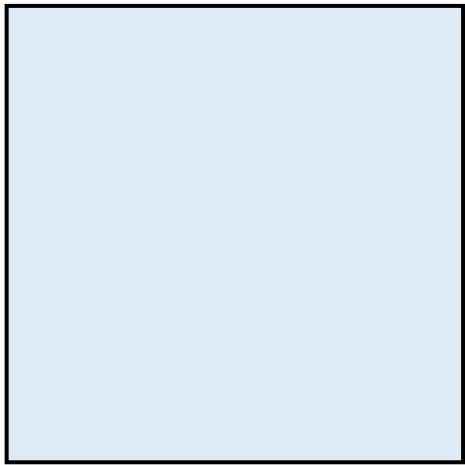



Maths – Lesson 3 Answers

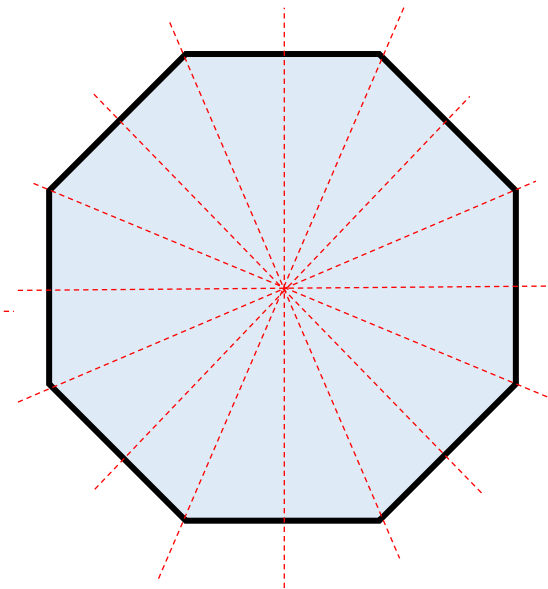
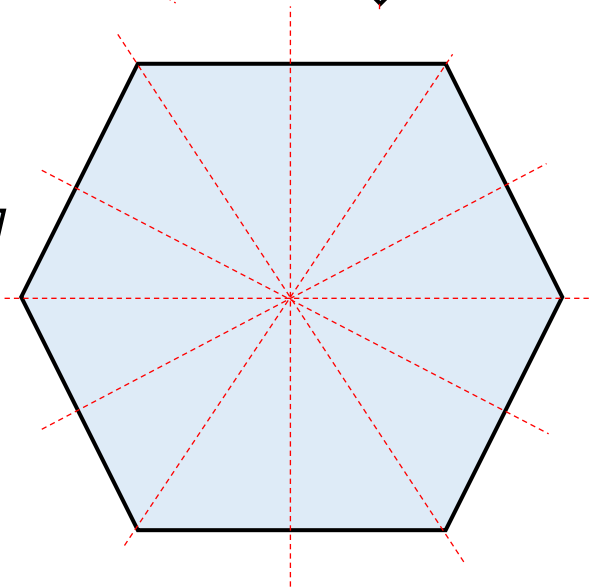
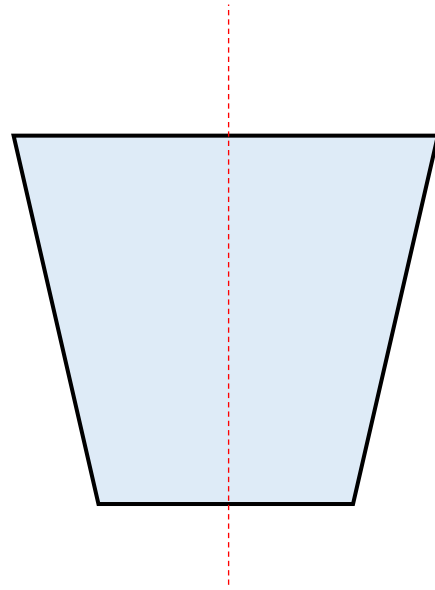
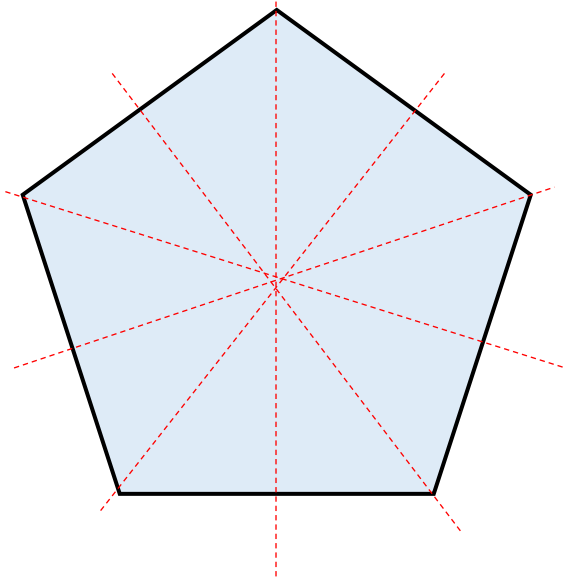
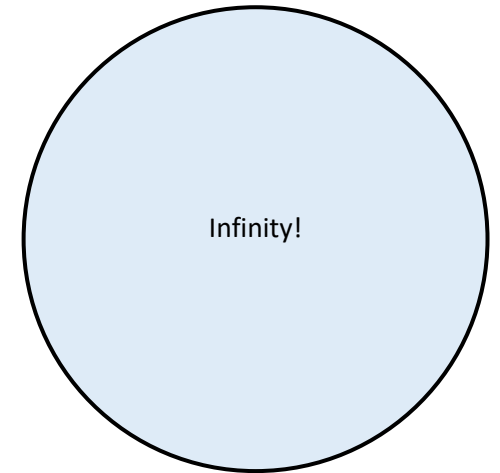
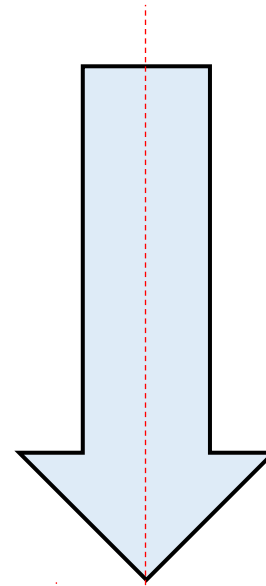
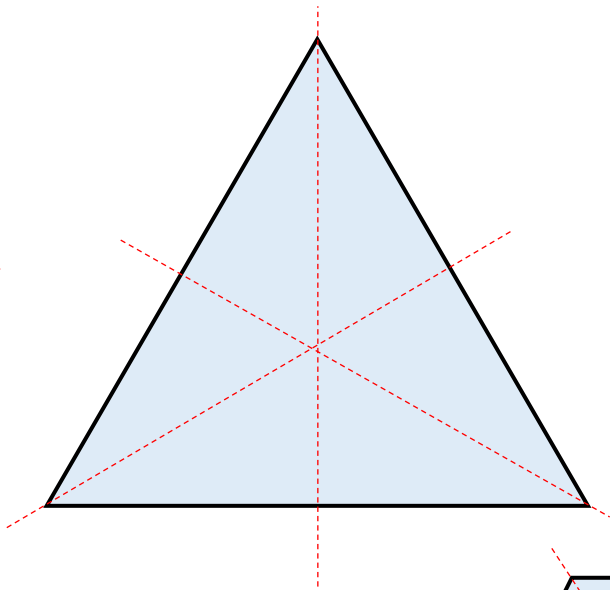
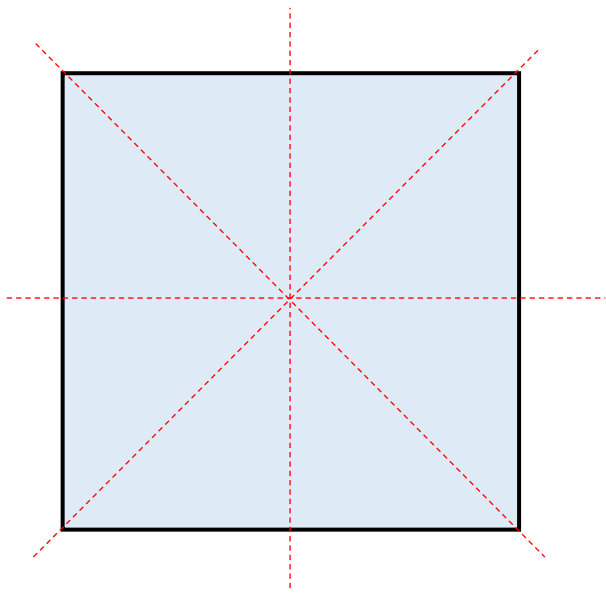



Maths – Lesson 4

Independent task...

Write the fraction of each shape.

Can you draw other representations of that fraction?

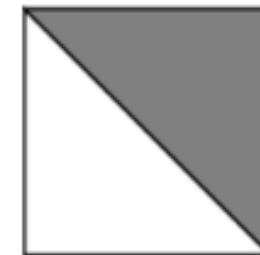
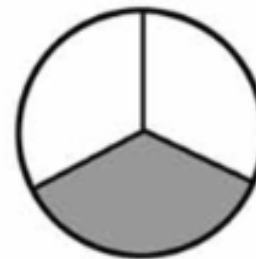
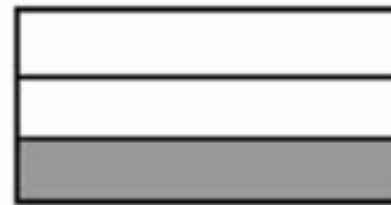
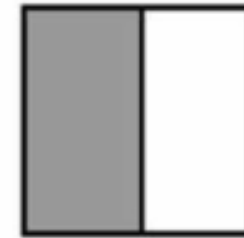
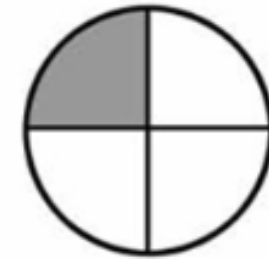
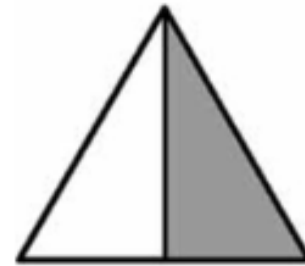

Challenge:

Can you create non-examples of:
One half?
One quarter?
One third?

A non-example is an example that is not correct!

E.g. this is a non-example of one quarter.





Maths – Lesson 4 Answers

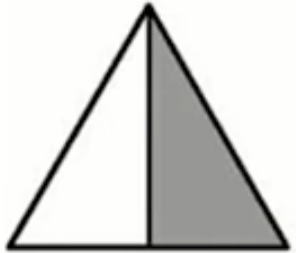

$$\frac{1}{2}$$

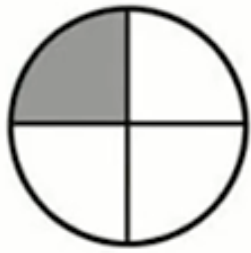

$$\frac{1}{4}$$



$$\frac{1}{4}$$

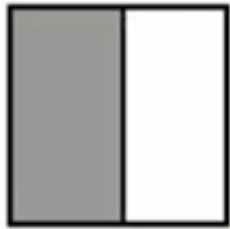

$$\frac{1}{2}$$

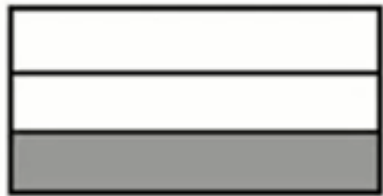

$$\frac{1}{3}$$

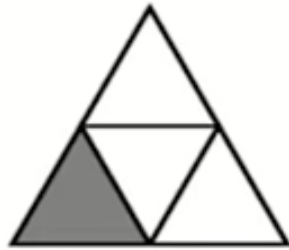

$$\frac{1}{4}$$



$$\frac{1}{3}$$



$$\frac{1}{2}$$



Maths – Lesson 5

Independent task

Can you describe what fraction is shaded and not shaded?

Remember to write the fractions correctly!

Challenge:





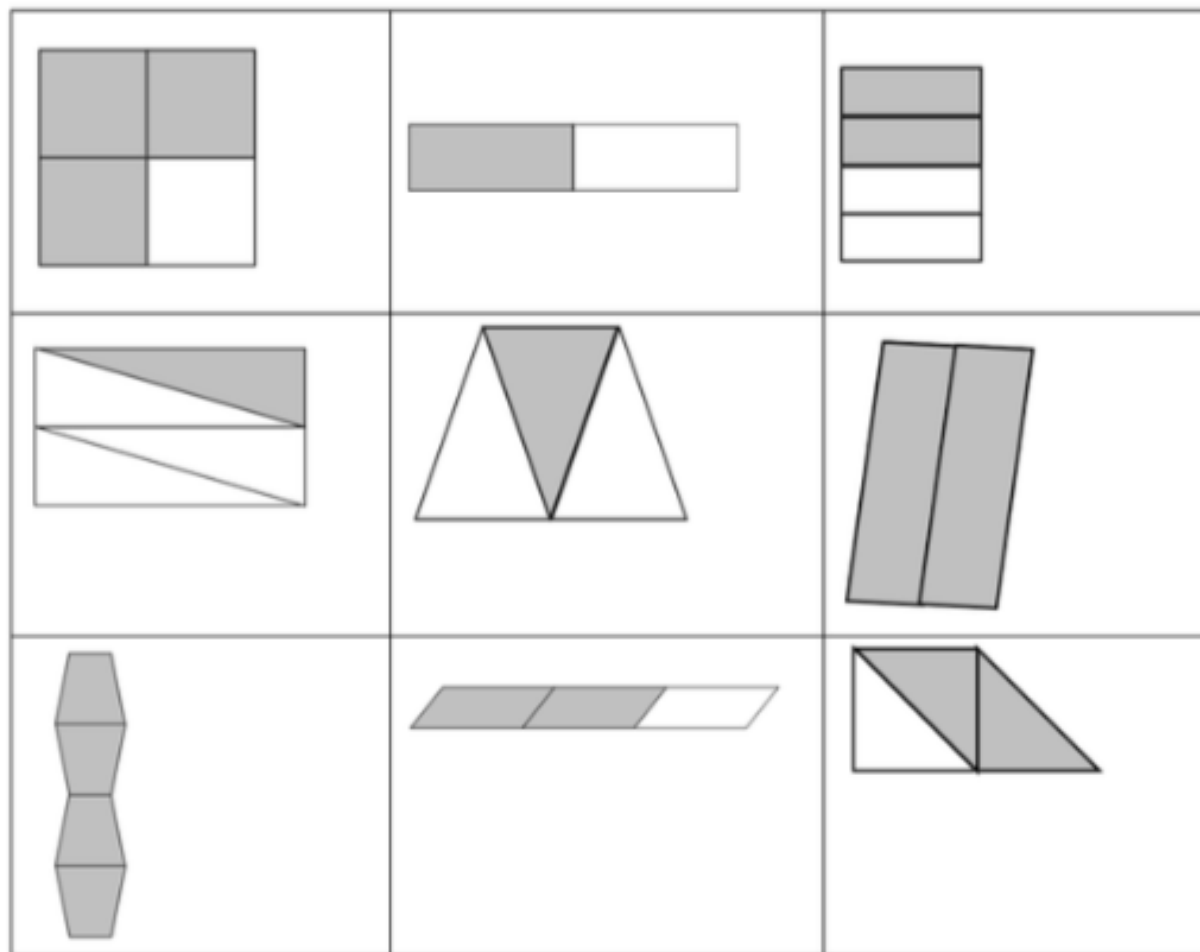
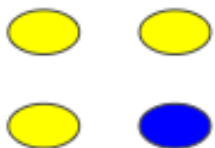

Can you represent the fractions you have written down with objects around your house.

E.g. three quarters of the sweets are yellow.

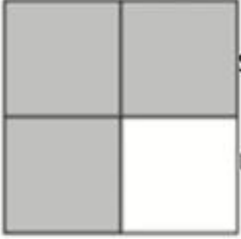

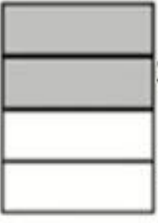

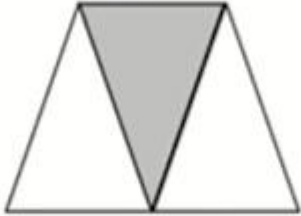
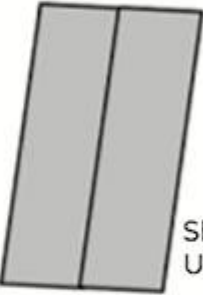
Maths – Lesson 5 Answers

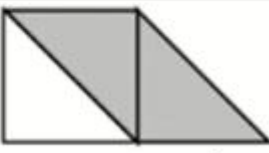
 <p>Shaded: $\frac{3}{4}$ Unshaded: $\frac{1}{4}$</p>	 <p>Shaded: $\frac{1}{2}$ Unshaded: $\frac{1}{2}$</p>	 <p>Shaded: $\frac{2}{4}$ Unshaded: $\frac{2}{4}$</p>
 <p>Shaded: $\frac{1}{4}$ Unshaded: $\frac{3}{4}$</p>	 <p>Shaded: $\frac{1}{3}$ Unshaded: $\frac{2}{3}$</p>	 <p>Shaded: $\frac{2}{2}$ Unshaded: $\frac{0}{2}$</p>
 <p>Shaded: $\frac{4}{4}$ Unshaded: $\frac{0}{4}$</p>	 <p>Shaded: $\frac{2}{3}$ Unshaded: $\frac{1}{3}$</p>	 <p>Shaded: $\frac{2}{3}$ Unshaded: $\frac{1}{3}$</p>